



The PX3TM offers an externally mounted surge solution that can be physically attached to the top or bottom of any panelboard, providing a reduced profile surge solution. PX3TM suppression filter systems feature a powerful failure-free ISMTM (Integrated Suppression Module). The ISMTM contains individual thermally fused and protected MOVs, surge-rated copper busing, robust filtering and advanced remote communications capabilities.

PRODUCT SPECIFICATIONS

General Specifications

Maximum Surge Current Rating	50kA Per Mode, 100kA Per Phase
Nominal Discharge Surge Current	I-n = 20kA
Safety Listings	UL Listed 1449 4th Edition for Type 1 and Type 2 SPD applications, cUL, and UL 1283 / Meets Requirements for UL 96A / Compliant to IEEE C62.41.1-2002, C62.41.2-2002 and C62.45-2002 / NFPA 70 [NEC], Article 285 / RoHS Compliant / CE, IEC 61643-11-2011 / FCC Part B Class B / EMC Directive 2004/108/EC / Low Voltage Directive 2006/95/EC
Protection Method	Thermally protected MOVs, Capacitive Filter
Product Design	Individual thermally fused and protected MOVs, and All Copper, Tin-plated Bus
Dimensions	9"H x 20"W x 5.75"D (without Integral Disconnect) 14"H x 20"W x 5.75"D (with Integral Disconnect)
Weight	18 lbs. (without Integral Disconnect) 20 lbs (with Integral Disconnect)
Enclosure Type	NEMA 1 Standard
Installation Location	Indoor
Operating Environment	-25°C to +60°C 5% – 95% Non-Condensing Humidity
Fault Current (SCCR)	200kAIC
Connection Method	Parallel
Protection Modes	All Modes (L-N, L-G, N-G, L-L)
Response Time	< 0.5 Nanoseconds
Operating Frequency	47 – 63 Hz
Warranty	15 Years

Filtering Attenuation Frequencies (Per Mil-Std-220B January 2000)**

10 KHz	100 KHz	1 MHz	10 MHz	Max at 142 KHz
18.1 dB	44 dB	22.8 dB	15.3 dB	54.6 dB

Single/Repetitive Surge Current Capacities (Tested)**

Protection Mode	Single Pulse Surge Current Capacity/Mode	Repetitive Surge Current Capacity/Mode
Line-to-Neutral	50,000A	5,000 Impulses
Line-to-Ground	50,000A	5,000 Impulses
Neutral-to-Ground	50,000A	5,000 Impulses
Line-to-Line	100,000A	10,000 Impulses
Per Phase	100,000A	10,000 Impulses

Maximum Continuous Operating Voltage (MCOV)

Voltage	L-N MCOV	Voltage	L-L MCOV
120V	150V	240V	300V
277V	320V	480V	552V
347V	420V	600V	690V

** Data based on actual tests. Contact factory for test reports

MODEL NUMBER SCHEME (PX3TM)

E.g.: PX3-050-208-3Y-MFT-M6E-F2D (as shown in above photo)

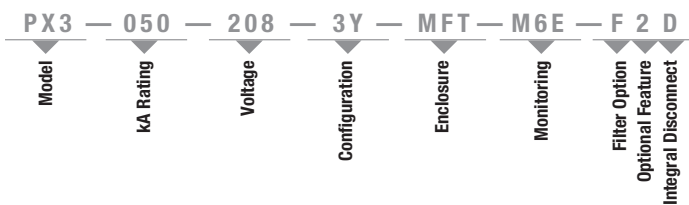

kA Rating (Must Choose One)

Available PX3TM kA Ratings:
050, 080, 100, 125*, 150*, 200*
*Not available with Integral Disconnect option.

Voltage* (Must Choose One)

208	120/208
240	120/240
380	220/380
480	277/480
600	347/600*

*Not available with Integral Disconnect option.

Configuration* (Must Choose One)

1G	1-Phase, Grounded
2G	2-Phase, Grounded, Split-Phase
3Y	3-Phase, Grounded, Wye
3R	3-Phase, Grounded, High-Resistance
3H	3-Phase, Grounded, High-Leg Delta
3D	3-Phase, Grounded, Delta

Enclosure (Must Choose One)

MFT	Metal, Flush Mount, Top Feed
MFB	Metal, Flush Mount, Bottom Feed
MST	Metal, Surface Mount, Top Feed
MSB	Metal, Surface Mount, Bottom Feed
SFT	Stainless, Flush Mount, Top Feed
SFB	Stainless, Flush Mount, Bottom Feed
SST	Stainless, Surface Mount, Top Feed
SSB	Stainless, Surface Mount, Bottom Feed

Monitoring (Must Choose One)

M0	No local monitoring (see remote MxX stand-alone option)
M1	LED/Phase + Audible Alarm, Dry Relay Contacts
M2	M1 + Surge Counter
M3	Advanced Monitoring, Character Display, Modbus RTU
M4E	M3 + Ethernet, Modbus TCP
M5	Advanced Monitoring, Graphics Display, Modbus RTU
M6E	M5 + Ethernet, Modbus TCP

Filter (Must Choose One)

F	Filter
N	No Filter

Optional Features (May Choose One)

1	Panel Mounted In-House
2	Test Port
4	Full Flush Cover
5	GE Version
6	Square D Version
7	Siemens, Eaton Cutler-Hammer

Disconnect Option

D	Integral Disconnect
Blank	No Disconnect

Stand-Alone Options

(To Be Ordered As Separate Items)

DTS	DTS-2 Diagnostic Test Set
MxX	Remote Monitor Extension M1X through M6EX
HPI	HPI Cable

DIMENSIONAL SPECIFICATIONS

PX3™/050 With Disconnect

	Inches	(mm)
H	14.00	(355.6)
W	20.00	(508.0)
D	5.75	(146.0)

PX3™/050 Without Disconnect

	Inches	(mm)
H	9.00	(228.6)
W	20.00	(508.0)
D	5.75	(146.0)

VOLTAGE/CONFIGURATION OPTIONS

Not all voltage configurations are displayed, contact Thomas & Betts Power Solutions for additional configurations.

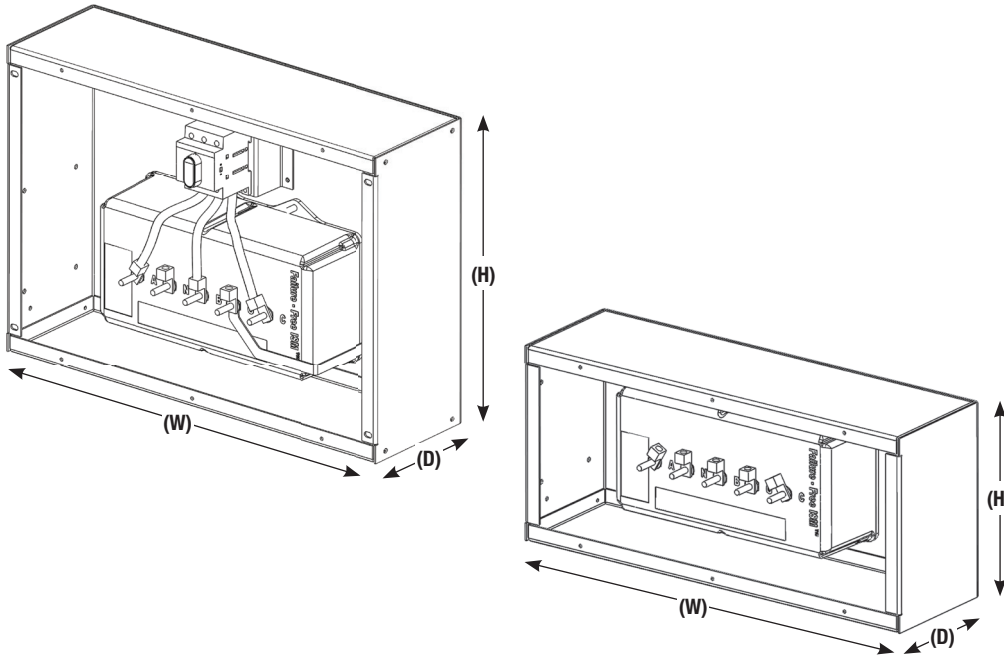

Voltage	Configuration					
	1G	2G	3Y	3R	3H	3D
120	X					
208	X		X	X		X
220	X	X		X		X
230	X					X
240	X	X			X	X
380		X	X	X		X
415		X	X	X		X
480		X	X	X		X
600		X	X	X		X

PX3™/50 PERFORMANCE DATA

System Voltage	120/240V or 120/208V				277/480V				347/600V*				480V Delta*	
	L-N	L-G	N-G	L-L	L-N	L-G	N-G	L-L	L-N	L-G	N-G	L-L	L-G	L-L
Protection Mode	L-N	L-G	N-G	L-L	L-N	L-G	N-G	L-L	L-N	L-G	N-G	L-L	L-G	L-L
MCOV	150	150	150	300	320	320	320	552	420	420	420	690	552	552
B3 Ring Wave 6kV, 500A	490	570	640	500	450	540	570	530	490	520	600	550	1450	530
B3/C1 Combo Wave 6kV, 3kA	614	629	634	1011	1013	1031	950	1857	1197	1219	1175	2369	1542	1857
C3 Combo Wave 20kV, 10kA	980	980	1170	1600	1420	1540	1600	2600	1670	1670	1730	2980	2270	2600
UL 1449 4th Edition VPR 6kV, 3kA	700	700	700	1200	1200	1200	1000	2000	1200	1500	1200	2500	1800	2000

*Not available with Integral Disconnect option.

All PX3™ systems voltage protection ratings (VPR) are peak values (±10%) measured from the 90° reference point and are in compliance with test and evaluation procedures outlined in ANSI/IEEE C62.41





Energía Verde RMS

Ahorra y contribuye con tu ambiente [®]

General Miguel Barragán #814
Aguascalientes, Ags.
01 (449) 145 2028
energiaverderms.com.mx